

# ashford

## INSTRUCTIONS

### RAINBOW ONE POT DYE KIT

To dye 1kg / 2.2lb Fleece wool you will need:

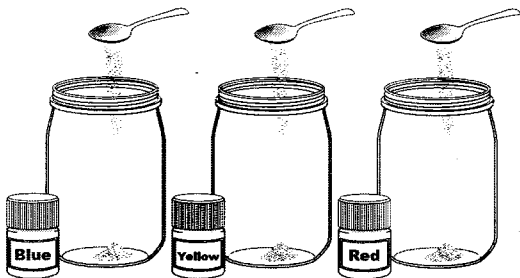
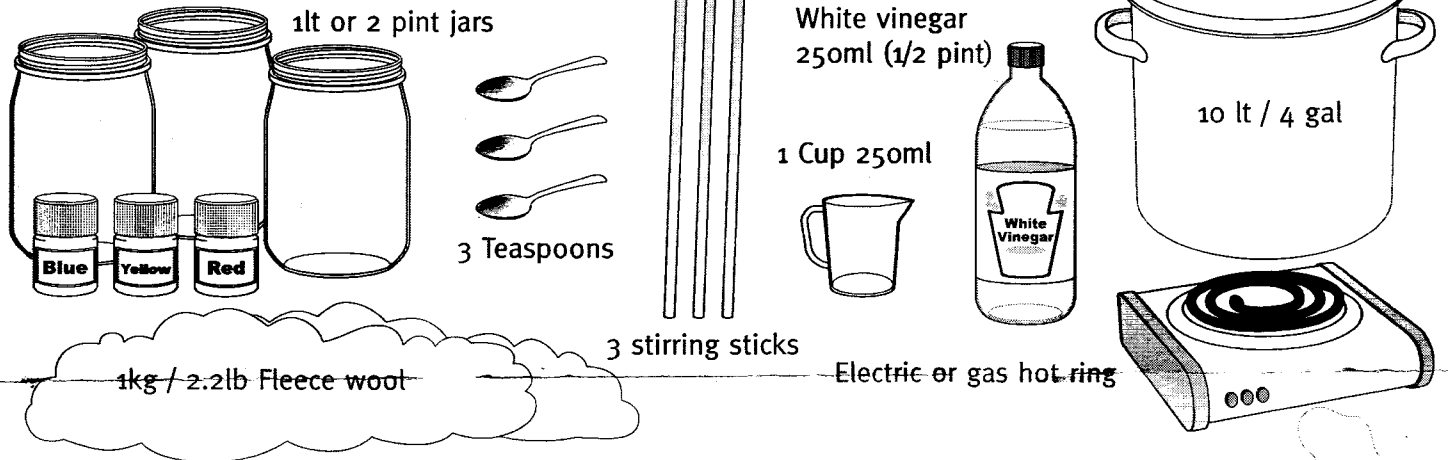

1. Add 1 measured teaspoon of dye powder to each jar.

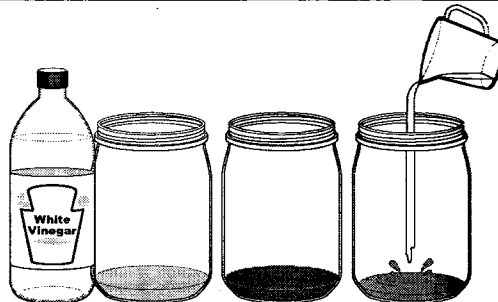

2. Add 1/4 cup of white vinegar to each jar.

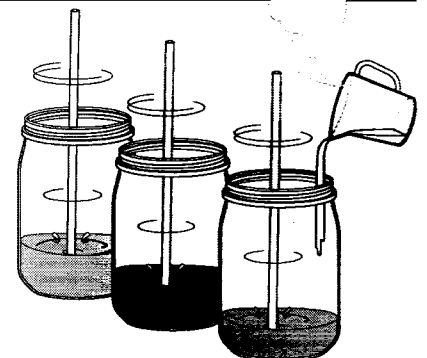

3. Add 1 cup of boiling water. Stir with a stick to dissolve dye.

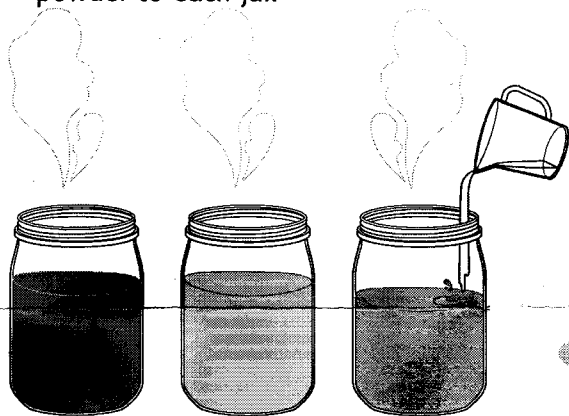

4. Fill remainder of jar with hot water. Approx. 2 cups.

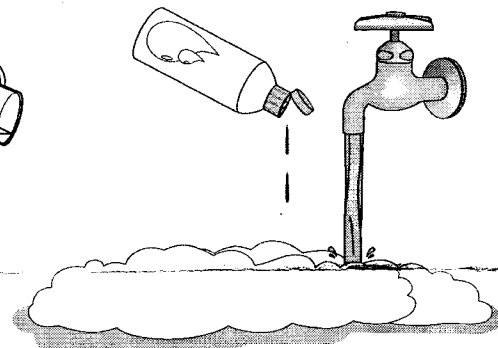

5. Wash the wool with warm water using 1/4 teaspoon of detergent. Rinse clean, leave wet.

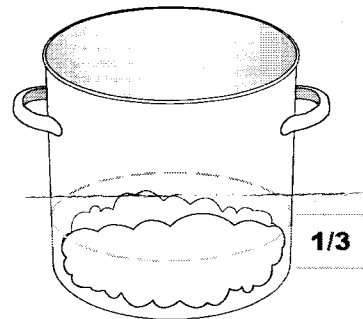

6. Put 1/3 of the wool in a pot.

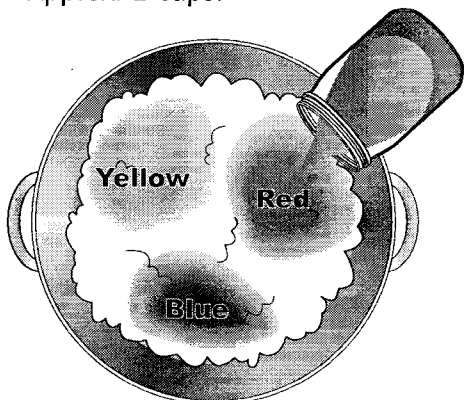

7. Pour some dye liquid in each area.

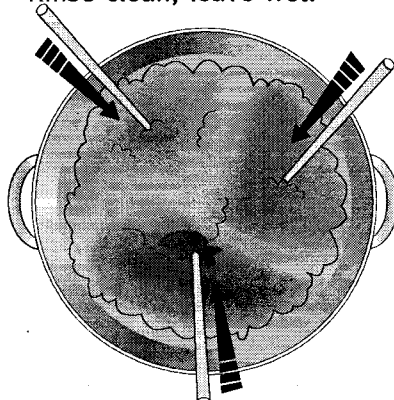

8. Press each colour area with a stick until you cannot see any white. Wool will soak up dye. DO NOT STIR!!

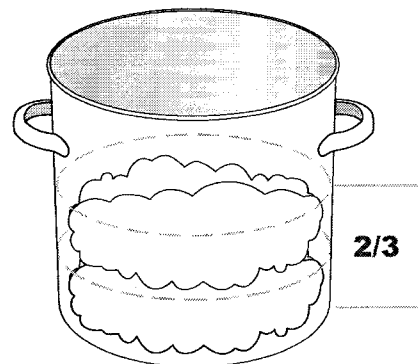

9. Add another 1/3 of the wool.

10. Repeat steps 7 & 8. Do not use too much dye liquid, just enough to colour the wool.

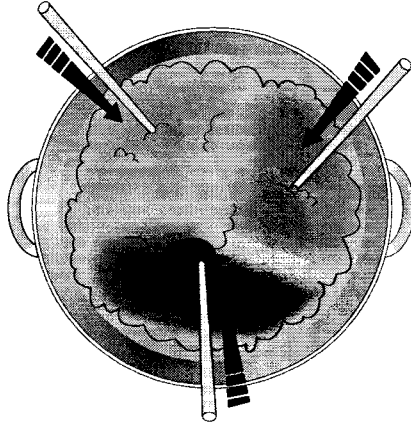
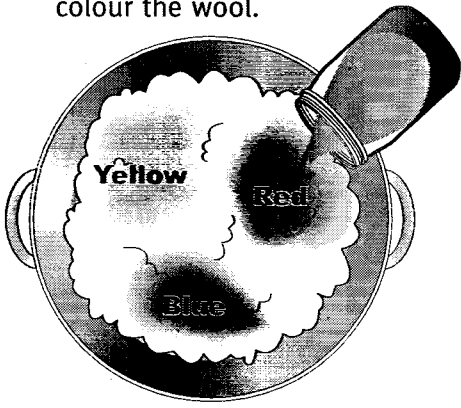

11. Add the rest of the wool.

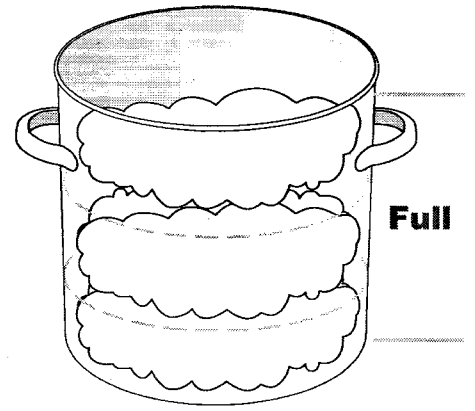

12. Repeat steps 7 & 8. Do not use too much dye liquid, just enough to colour the wool.

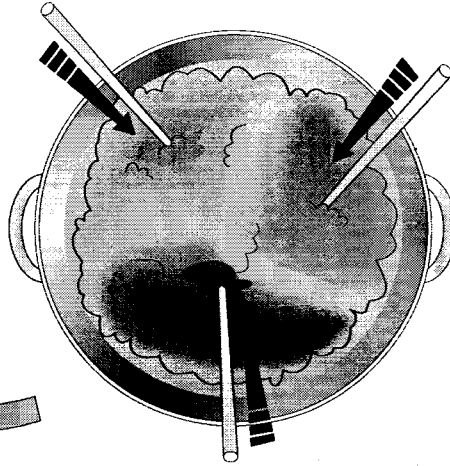
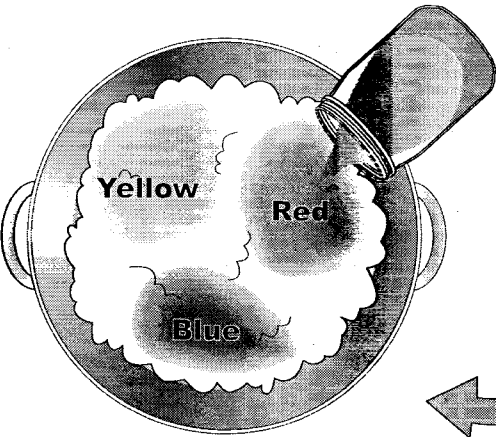
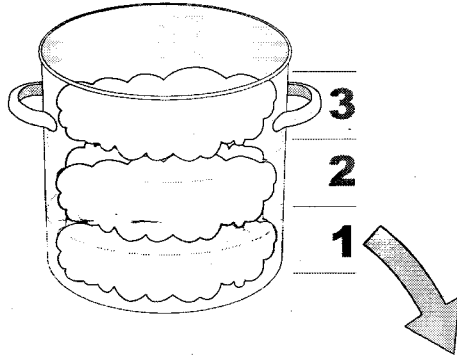

13. Place lid on pot.

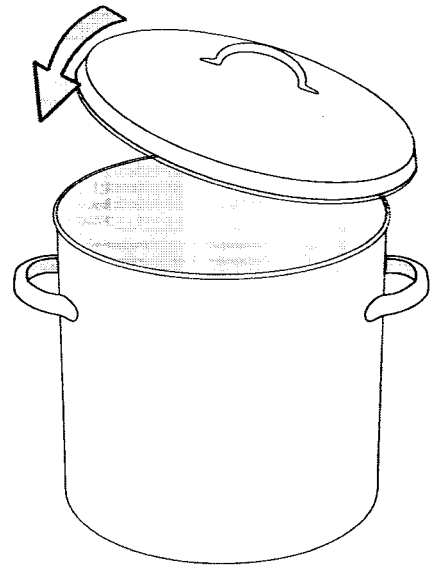

14. Bring to the boil then turn down to a medium heat. Cook for a maximum of 30 minutes or until the liquid is clear.

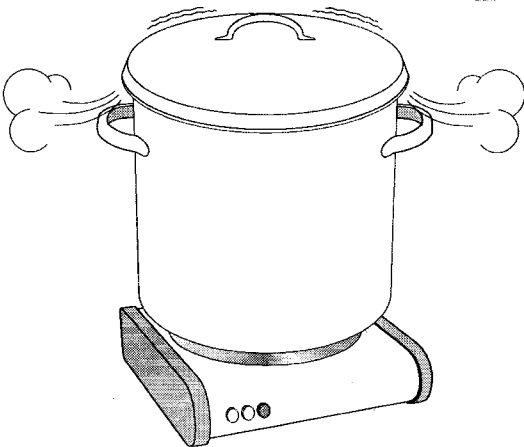

15. Drain wool, allow to cool, then rinsing with cold water. Spread out to dry.

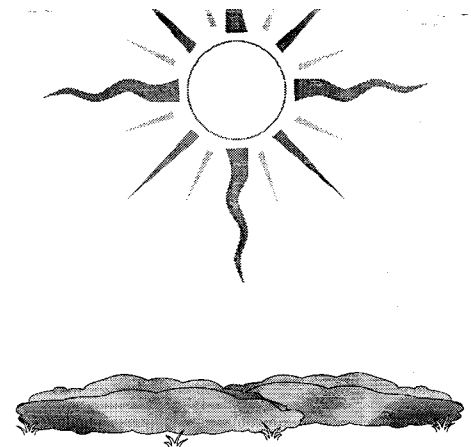
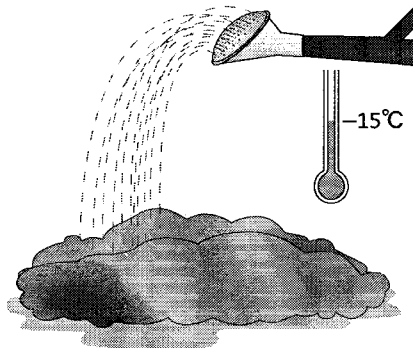

Ashford Handicrafts Ltd.  
Factory and Showroom: 415 West Street,  
PO Box 474, Ashburton, New Zealand  
Telephone 64 3 308 9087  
Facsimile 64 3 308 8664  
Email: sales@ashford.co.nz  
Internet: www.ashford.co.nz

Ashford Guarantee  
Thank you for purchasing this Ashford product. In the unlikely event there is any fault in manufacture we will replace the item. To validate our guarantee please visit our website or write to us.  
Please also join our Ashford Club for the Wheel Magazine, competitions and more at [www.ashfordclub.co.nz](http://www.ashfordclub.co.nz)